

A LASER FLASH APPARATUS FOR THERMAL DIFFUSIVITY AND SPECIFIC HEAT CAPACITY MEASUREMENTS

K. Shinzato¹ and T. Baba²

¹Kyushu Laboratory, Kyoto Electronics Manufacturing Co. Ltd. (KEM), 1-2 Nakabarushinmachi, Tobata-ku, Kitakyushu, Fukuoka 804-0003, Japan

²National Research Laboratory of Metrology (NRLM), 1-1-4 Umezono, Tsukuba, Ibaraki 305-8563, Japan

Abstract

We have developed a laser flash apparatus for simultaneous measurements of thermal diffusivity and specific heat capacity of solid materials by introducing recent technical progress: uniform heating by a homogenized laser beam using an optical fiber with a mode mixer, measuring transient temperature of a specimen with a calibrated radiation thermometer, analyzing a transient temperature curve with a curve fitting method, to achieve differential laser flash calorimetry. Thermal diffusivity, specific heat capacity and thermal conductivity of glassy carbon and molybdenum were measured in the temperature range from 300 to 1100 K.

Keywords: laser flash method, simultaneous measurement, solid materials, specific heat capacity, thermal conductivity, thermal diffusivity

Introduction

The technique for measuring thermal diffusivity and specific heat capacity by the flash method was developed in 1961 by Parker *et al.* [1], and a laser-flash calorimetry has been developed by Takahashi *et al.* [2].

Followed by development of the uniform radiative heating method [3] which improves the former method in measuring thermal diffusivity more accurately, a new measuring method on specific heat capacity by the laser flash method and the laser flash differential calorimetry [4, 5], has been introduced.

In order to obtain thermal conductivity of high accuracy up to a higher temperature range, we should first measure the thermal diffusivity by the laser flash method and next measure the specific heat capacity by the differential scanning calorimetry (DSC), the drop calorimetry, or the pulse current heating method. This procedure requires at least two different apparatus and two different specimens, one for thermal diffusivity measurements and another for specific heat capacity measurements.

The purpose of this work is to develop a laser flash thermophysical property apparatus by which we can measure the key thermophysical properties (thermal

diffusivity, specific heat capacity, thermal conductivity) of solid materials by single apparatus from room temperature to higher temperatures (over 1700 K) under highly vacuum or inert atmosphere.

Principle

Solving one dimensional thermal conduction equation with the assumption of the ideal conditions gives the following temperature response on the rear face of the specimen:

$$\Delta T = \Delta T_m \left[1 + 2 \sum_{n=1}^{\infty} (-1)^n \exp\left(\frac{-n^2 \pi^2 \alpha t}{L^2}\right) \right] \quad (1)$$

where α and L are the thermal diffusivity and the thickness of the specimen, respectively; and ΔT is the temperature rise of the specimen, ΔT_m is its maximum value, t is time after the pulse heating. Examples of the temperature response are shown in Fig. 1 as the relation between t and $\Delta T/\Delta T_m$.

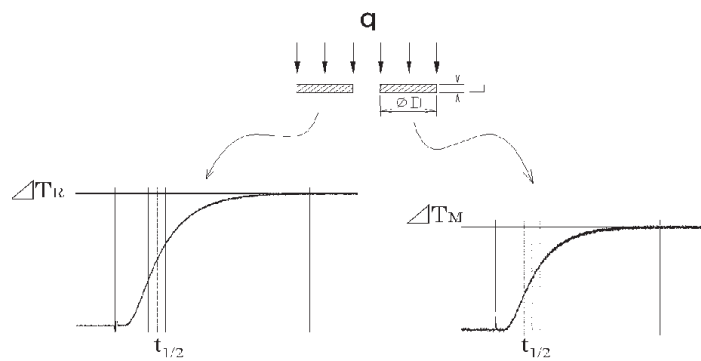

Fig. 1 Simultaneous measurement of thermal diffusivity and specific heat capacity by the laser flash differential calorimetry

From Fig. 1, setting the time when the temperature reaches $\Delta T/\Delta T_m = 1/2$ as $t_{1/2}$, the thermal diffusivity can be calculated from the following equation:

$$\alpha = \frac{0.1388L^2}{t_{1/2}} \quad (2)$$

The specific heat capacity can be calculated from the following Eq. (3) using the temperature rise of the measured specimen and the irradiated heat on the previously performed calibration data of the heat irradiated by the laser pulse beam and the intensity of the laser pulse.

$$c_p = \frac{aAq}{m\Delta T_m} \quad (3)$$

where c_p is the specific heat capacity, a is the absorptivity of the irradiated face, A is the surface area, q is the energy density of the laser pulse, m is the mass of the specimen and ΔT_m is the maximum value of the temperature rise.

In the conventional procedure of heat capacity measurements, there are lots of factors for measurement errors and, such as from adhering a thermocouple to the rear face of the specimen, unreproducible irradiating conditions for the reference and the measured specimen, different absorptivity and emissivity for the surfaces of both specimens, etc.

In the differential laser flash calorimetry, a reference specimen and a measured specimen with the same diameter, the front and rear faces of which were covered with black coating under the same condition at the same temperature are set close together and irradiated uniformly by a homogenized laser beam as shown in Fig. 1. Thermal diffusivity values are determined by analyzing the transient temperature curves on the rear face of both specimens by the curve-fitting method [6], followed by evaluating specific heat capacity by comparing the temperature rises of the reference and the measured specimens. In this case, the temperature rises of both reference and measured specimen are measured with a non-contact infrared radiation thermometer. The reference specimen is a material with known specific heat capacity. In addition, the two specimens are considered to be adiabatic to the environment in low temperature range as such a heat transfer by conduction is small because both specimens are allowed to contact the specimen holder with a minimum area.

The temperature rises for the reference and the measured specimen, when the laser beam with the energy density q is uniformly irradiated and the absorptivity of the irradiated faces for both specimens are same, ΔT_R and ΔT_M can be expressed as:

$$\Delta T_R = \left(\frac{A}{mc_p} \right)_R q \quad (4)$$

$$\Delta T_M = \left(\frac{A}{mc_p} \right)_M q \quad (5)$$

where the suffixes R and M indicate the reference and the measured specimen, respectively.

Thus, the specific heat capacity of the measured specimen c_{pM} can be calculated, once, c_{pR} of the reference specimen is known and the temperature increase ratio or the radiance ratio is determined, from the following equation:

$$c_{pM} = \frac{A_M m_R \Delta T_R}{A_R m_M \Delta T_M} \quad (6)$$

The thermal conductivity λ can be calculated from the definitive Eq. (7) when the density ρ of the measured specimen is known:

$$\lambda = \rho c_p \alpha \quad (7)$$

Furthermore, if the density of the reference specimen ρ_R is known, ρc_p of the measured specimen can be obtained from the following equation:

$$(\rho c_p)_M = \frac{L_R \Delta T_R}{L_M \Delta T_M} (\rho c_p)_R \quad (8)$$

where, L_R and L_M are the thickness of the reference and the measured specimens, respectively.

Then, substituting this value into Eq. (7) gives the thermal conductivity λ_M . Thus, α and c_p can be measured simultaneously and λ can be estimated at the same time.

Apparatus

The apparatus has introduced not only the basic technology concerning the homogenization of laser beam by the optical fiber system [7], the measurement of the transient temperature on the rear surface of the specimen by high-speed infrared thermometer with a temperature scale [8], contact measurement at steady state temperature and the calculation of thermal diffusivity by the curve fitting method [6, 9] – but also the new technology of the differential laser flash calorimetry consists of a specimen holder which can hold two specimens (reference and measured) up to the high temperatures for simultaneous measurements of thermal diffusivity and specific heat capacity and a high-speed infrared thermometer which can simultaneously measure the temperature of the rear face of two specimens.

Figure 2 shows the block diagram of the differential laser flash apparatus. The apparatus consists of a pulse laser, an optical fiber system with mode mixer as a pulse beam introduction unit, chamber with a sample support, a high-speed infrared thermometer (InSb elements, cooled by liquid nitrogen), differential amplifiers and a

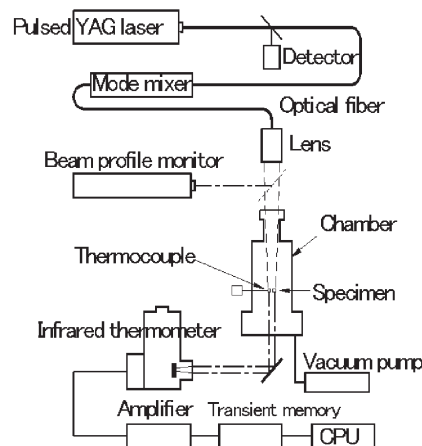

Fig. 2 Block diagram of the laser flash apparatus

transient memory. In addition, this apparatus is equipped with a beam profile monitor to provide the visual checking of the uniformity of a pulsed laser beam and other units – a vacuum pump, a circulating water-cooling unit and a personal computer for the analysis of measured data, the details have been shown in [10].

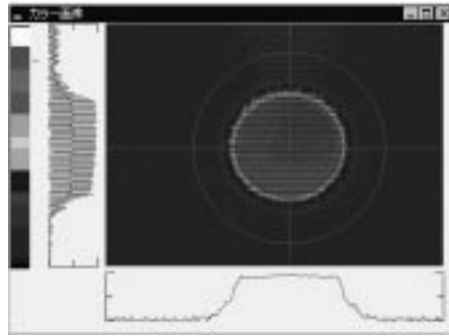

Fig. 3 An example of spatially uniformity of energy density of a pulsed laser beam by the profile monitor

An Nd-YAG laser (wavelength: 1.06 μm) is used as a pulsed laser and the half width of the laser pulse is selectable to either 300 or 500 μs mode with a switch. The output power of the laser can be changed up to 2 J for 300 μs mode and 5 J for 500 μs mode. The pulsed laser beam is focused into the optical fiber and homogenized in beam profile by the mode mixer and irradiated onto the specimens. The charging time required for one pulse shot is 30 s. Figure 3 shows an example of spatial energy distribution of a single-pulsed laser beam, where two-dimensional energy intensity distribution for a single beam is displayed in pseudo colors and one-dimensional energy intensity distributions in both x - and y -directions are also shown.

The chamber can be operated in the range from room temperature to 1800 K and the vacuum level of 0.05 Pa ($3.75 \cdot 10^{-4}$ torr) or lower to prevent oxidation and dirt proof and to suppress the heat loss caused by convection and can also be operated in inert gas atmosphere. The specimen is opaque and is a disk of 10 or 5 mm in diameter and from 0.5 to 3 mm in thickness, and black coating to absorb the laser beam is required for the specimen which is transparent, translucent or low emissivity. The specimen with the diameter of 5 mm is used for the simultaneous measurements of thermal diffusivity and specific heat capacity. Figure 4 shows two kinds of the specimen holder for 5 and 10 mm diameter, respectively.



Fig. 4 Photographs of specimen holders for 5 mm diameter (left) and 10 mm diameter (right), respectively

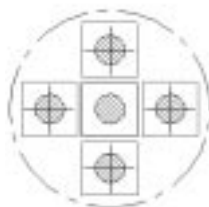

Fig. 5 Arrangement of the five elements (InSb, 0.6 mm diameter)

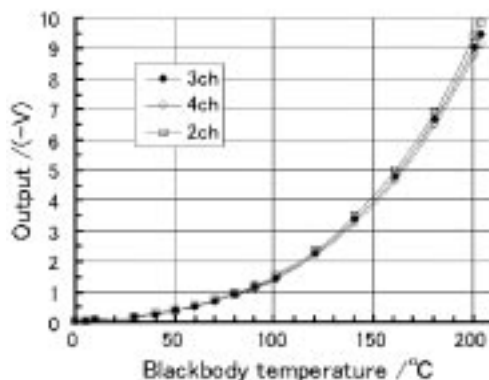

Fig. 6 Calibration curves of three elements of the infrared radiation thermometer

A high-speed infrared radiation thermometer equipped with five sensing elements was developed and calibrated with a blackbody for the temperature scale. Figure 5 shows the arrangement of the five elements. Figure 6 shows examples of the relation between the output signal of each element and the blackbody temperature. The deviation between the data and the characteristic equation is 0.2% in the range from 278 K (5°C) up to 473 K (200°C). And the precision of temperature calibration is ± 0.2 K. The temperature response of the infrared radiation thermometer including the amplifier has been evaluated by using an instrument for measuring time-response properties [11]. It has been checked that the response is fast enough to respond the emitting signals, up to 10 kHz of infrared-emitting diode, without decrease of amplification factor or delay of phase.

Results

The differential calorimetry in the simultaneous measurement by the laser flash method is a comparative measurement, and the specific heat of reference materials must be known. Glassy carbon (GC) and molybdenum were chosen as reference materials because GC is an object which has been studied as a candidate of standard reference materials of thermal diffusivity to be supplied by the National Research Laboratory of Metrology (NRLM), Japan and molybdenum is a standard reference

Table 1 The results of 10 and 5 mm diameter specimens at room temperature

	Material	Thickness/ mm	Diameter/ mm	Mass/g	$\rho/\text{kg m}^{-3}$	Temp. rise/K	$t_{1/2}/\text{ms}$	$\alpha/\text{m}^2 \text{s}^{-1}$	$C_p/\text{J kg}^{-1} \text{K}^{-1}$	$\lambda/\text{W m}^{-1} \text{K}^{-1}$
Conventional comparative method										
(a)	R Molybdenum	1.011	9.874	0.7842	10135	2.60	2.615	5.38E-05	249	136
	M Molybdenum	1.996	9.895	1.5599	10168	1.33	10.04	5.56E-05	247	139
Simultaneously comparative method										
(b)	R Molybdenum	0.999	4.979	0.1966	10113	1.50	2.410	5.71E-05	249	144
	M Molybdenum	0.999	4.986	0.1969	10100	1.50	2.500	5.61E-05	249	141
(c)	R Glassy carbon	0.965	5.001	0.0291	1536	3.81	21.27	5.91E-06	724	6.6
	M Glassy carbon	0.958	5.003	0.0292	1551	3.86	21.06	5.93E-06	712	6.6
(d)	R Molybdenum	0.999	4.986	0.1969	10100	1.57	2.385	5.81E-05	249	146
	M Tungsten	0.982	5.008	0.3694	19107	1.53	1.940	6.86E-05	137 (133)*	179 (174)*
(e)	R Glassy carbon	0.456	5.002	0.0133	1485	8.16	4.950	6.12E-06	707	6.4
	M Zirconia**	0.508	4.994	0.0604	6073	3.20	28.62	1.16E-06	411	2.9
	R Glassy carbon	0.963	5.003	0.0291	1538	3.64	21.00	5.97E-06	–	6.5
	M Zirconia**	–	–	–	–	3.06	31.23	1.12E-06	406	2.7
	R Glassy carbon	1.368	4.993	0.0407	1520	2.43	41.04	6.12E-06	–	6.6
	M Zirconia**	–	–	–	–	2.76	31.72	1.11E-06	419	2.8
	R Glassy carbon	1.960	4.994	0.0586	1527	1.72	79.50	6.39E-06	–	6.9
	M Zirconia**	–	–	–	–	2.71	31.74	1.11E-06	434	2.9

R: Reference specimen

M: Measured specimen

α determined by CF-method

C_p of molybdenum is given by NIST

C_p of glassy carbon is given by calculation from [12]

*Values in parentheses have been cited from [13]

**These four lines are description for the same zirconia specimen of 0.508 mm thick

material (SRM781) of specific heat capacity supplied by the National Institute of Standards and Technology (NIST), USA.

The equal absorptivity of the surface for both specimens is essentially important for specific heat capacity measurements. This condition can be confirmed by comparing the surface temperatures on the reference material with those on the measured specimen using the multiple-element infrared radiation thermometer when setting the specimen. The equality of the emissivity between two specimens can be re-confirmed with changing the setting positions of the specimens.

In order to make the emissivity the same value, the surface of the specimen was polished with abrasive paper and sprayed with dry graphite (DGF) for surface blackening.

Both reference and measured specimens are set horizontally, i.e. perpendicular to the laser beam as shown in Fig. 1. The dimension and mass of the specimen are measured with a micrometer (minimal scale: 1 μm) and a precision electronic balance (minimal scale: 0.1 mg), respectively – after and before DGF coating.

Figures 7a and 7b show the results of simultaneous measurements using the same materials as the reference materials from room temperature to 1100 K range on glassy carbon and molybdenum, respectively. In the figures the measured thermal diffusivity α , specific heat capacity c_p and thermal conductivity λ are shown on the same temperature scale.

The measured α , c_p and λ of each specimen at room temperature are shown in Table 1. For comparison, α and c_p of molybdenum specimens of 2 mm in thickness and 10 mm in diameter were measured by the laser flash method under the standard configuration for a single specimen instead of the differential configuration for a pair of specimens. The irradiation energy density was determined from the heat received on molybdenum with 1 mm of thickness as the reference specimen. For both molybdenum specimens with 10 and 5 mm of diameter, the results show the agreements

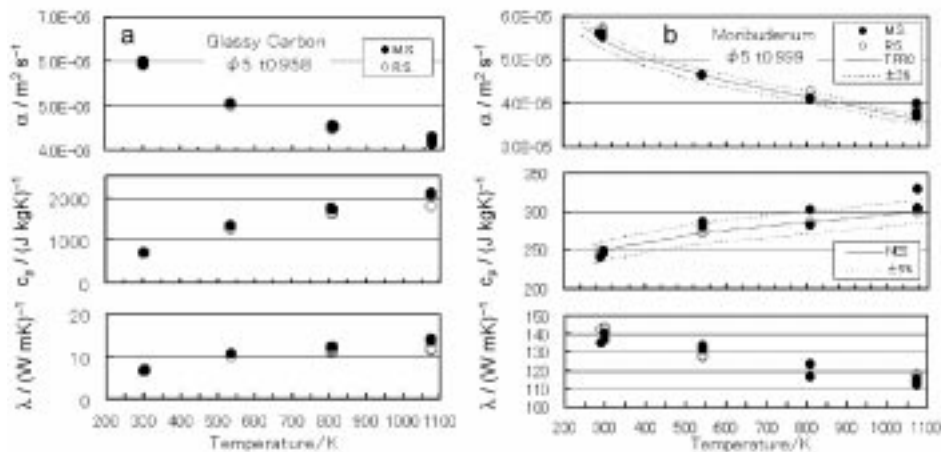

Fig. 7 The result of simultaneous measurements; a – glassy carbon, 5 mm diameter; b – molybdenum, 5 mm diameter

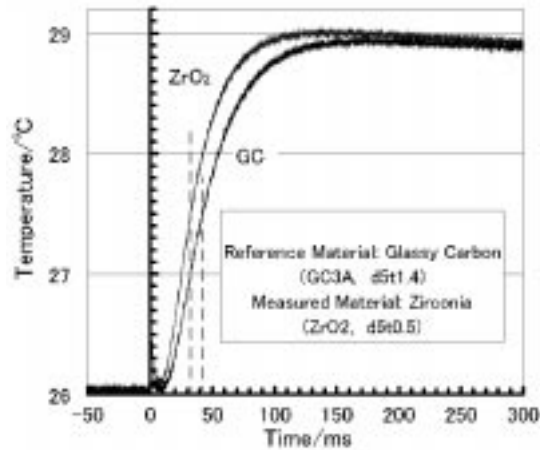

Fig. 8 Examples of transient temperature curves observed for simultaneous measurements of thermal diffusivity and specific heat capacity

within $\pm 2\%$ for thermal diffusivity, within 1% for specific heat capacity and within $\pm 3\%$ for thermal conductivity in Table 1 (a) and (b), respectively. The results of the simultaneous measurement of two specimens with 5 mm diameter of glassy carbon show good agreement within 1% in Table 1 (c).

As examples, the results on tungsten and zirconia under atmospheric pressure at room temperature are also shown in the Table 1 (d) and (e). The reference materials are molybdenum and glassy carbon, respectively. The results on tungsten agree well with the values of literature [13] in Table 1 (d). The validity of the differential laser flash calorimetry was confirmed by measuring the same specimen of zirconia with using each of glassy carbon specimens of different thickness, 0.456, 0.963, 1.368 and 1.960 mm, in turn as the reference specimen as shown in Table 1 (e).

Specific heat capacity values derived from reference of different thickness agree within 6%. Figure 8 shows examples of transient temperature curves of zirconia and glassy carbon, as the measured and the reference specimen, respectively, in the simultaneous measurements of thermal diffusivity and specific heat capacity.

Conclusions

Based on the standard laser flash technique for measuring thermal diffusivity with recent technical progress and the newly proposed differential calorimetry, we have developed a thermophysical property apparatus, which can simultaneously measure thermal diffusivity and specific heat capacity with small uncertainty and obtain thermal conductivity by a single shot of laser pulse.

We have presented the measurement examples on thermal diffusivity, specific heat capacity and thermal conductivity of glassy carbon and molybdenum, in the temperature range of room temperature to 1100 K.

The authors would like to thank Dr. J. Ishii of National Research Laboratory of Metrology for valuable suggestions and guidance for design and calibration method of multiple element infrared thermometer.

References

- 1 W. J. Parker, R. J. Jenkins, C. P. Butler and G. L. Abbot, *J. Appl. Phys.*, 32-9 (1961) 1679.
- 2 Y. Takahashi, H. Yokokawa, H. Kadokura, Y. Sekine and T. Mukaibo, *J. Chem. Thermodynamics*, 11 (1979) 379.
- 3 T. Baba and A. Ono, *Proc. of 4th Asian Thermophysical Properties Conf.*, (1995) 581.
- 4 T. Baba, *Proc. of 11th Japan Symposium on Thermophysical Prop.*, (1990) 449.
- 5 C. W. Lee, T. Baba and A. Ono, *Jpn. J. Thermophysical Properties (Netsu Bussei)*, 9 (1995) 224.
- 6 A. Cezairliyan, T. Baba and R. Taylor, *Int. J. Thermophys.*, 15 (1994) 317.
- 7 T. Baba, J. H. Hong and A. Ono, *Proc. of 2nd Asian Thermophysical Properties Conf.*, (1989) 127.
- 8 T. Baba, M. Kobayashi and A. Ono, *Jpn. J. Thermophysical Properties (Netsu Bussei)*, 8 (1994) 143.
- 9 CFP32 for Windows Ver. 2.03 (1998), <http://www.nrlm.go.jp/section/Joho/CFP>.
- 10 K. Shinzato, *Proc. of 20th Japan Symposium on Thermophysical Prop.*, (1999) 631.
- 11 J. Ishii and T. Baba, *Jpn. J. Thermophysical Properties (Netsu Bussei)*, 13 (1999) 70.
- 12 A. T. D. Butland and R. J. Maddison, *AEEW-R-815* (1972).
- 13 G. K. White and M. L. Minges, *Int. J. Thermophysics*, 18 (1997) 1269.